

WHAT ARE PELLETS?

The Austroflamm „Integra“ is a pellet stove, designed to burn wood pellets. Pellets are made of waste material from saw mills, woodworking operations as well as dead wood from forestry operations. The wood pellet industry is organized through the **A.P.F.I. (Association of Pellet Fuel Industries)**, and it is recommended that only wood pellets, manufactured to the standards set by the A.P.F.I. be used with this stove. All pellets made to these standards are labelled with an official A.P.F.I. registration number on the bag. This guarantees the consumer that the fuel is certified as to moisture and ash content.

The A.P.F.I. allows two grades: standard and premium quality pellets. The important difference in these pellet grades is their ash content.

Premium quality:
1% (or less) ash content

Standard quality:
Up to 3% ash content

A higher ash content in the fuel means more combustion residue which, in turn, means shorter cleaning intervals. See Routine Maintenance .

SEE PAGE
23

ASH

It is highly recommended that you use the lowest ash-content fuel available. Fuel with a 3% ash content may require the stove to be cleaned as often as every day or two, whereas a fuel with a 1% ash content may only require cleaning once every one to two weeks. This ash - since it is a completely natural product - makes an excellent fertilizer for all your garden plants. However, it should be aged and "quenched" with water before use.

Please note that use of improper fuels will void your warranty and may cause damage or seriously affect the performance of your stove.



The current A.P.F.I. standards for residential pellet fuels are as follows:

	Standard Quality	Premium Quality
Heating value	8,200 BTU/lb. (minimum)	8,200 BTU/lb. (minimum)
Bulk density	40 lb/ft ³ (minimum)	40 lb/ft ³ (minimum)
Moisture content	8% (maximum)	8% (maximum)
Ash content	3 % (maximum)	1% (maximum)
Size	1/4" - 5/16" diameter 1 1/2" long (maximum)	1/4" - 5/16" diameter 1 1/2" long (maximum)
Fines	0.5% (maximum) through a 1/8" screen	0.5% (maximum) through a 1/8" screen

Caution: Burning dirty or wet pellets or pellets containing salt contaminates the environment, imperils the function of your pellet stove, and may mean the loss of manufacturer's warranty.



Caution, please: Embers may be embedded and hidden in the ash. Store in metal containers only!

STORING PELLETS:

To guarantee that your pellets will burn without any problems, they should be stored in a dry and clean environment.

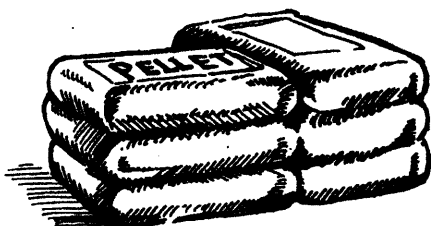

If you have any further questions regarding fuel for use in your Austroflamm stove, please contact your dealer or the A.P.F.I.

Association of Pellet Fuel Industries

555-116th NE/Suite 250
Bellevue, WA 98004
Phone: 206-453-8422

CLINKERING

„Clinkering“ is a process that takes place in the combustion pot. A clinker is a solid substance that accumulates due to heat and silica working together and forming deposits during combustion. Silicia is actually sand and is present in all pellet fuels along with a variety of other impurities. When clinkering takes place, these hard substances will tend to clog the holes

at the bottom of the combustion pot. This adversely affects the performance of the stove as it cuts off the air supply to the combustion process. The burn pot should be checked periodically for clinkers, and all hard substances should be removed from it so as to allow proper air flow through the bottom. A tool is provided with your AUSTROFLAMM Integra pellet stove to be used in cleaning these holes. It should be noted that even A.P.F.I.-approved pellet fuels will allow some clinkering.



For more information about how often you need to clean your stove see page 23.

AUSTROFLAMM will not be responsible for damage caused by the use of inferior or improper grades of pellet fuels. AUSTROFLAMM is not responsible for the performance of the stove due to the use of non-approved fuels.

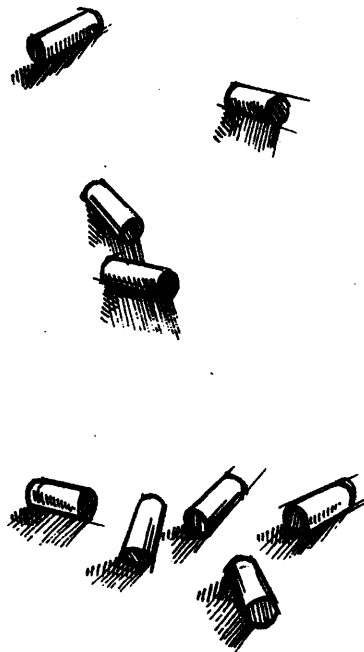
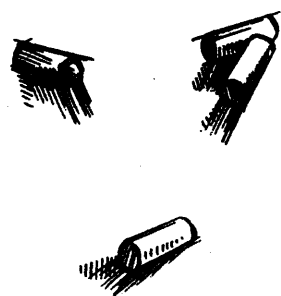

TECHNOLOGY - ADVANCED AND SAFE

1. Hopper
2. Auger
3. Fire pot
4. Air intake with electronic sensor
5. Heat exchanger forechamber
6. Heated convection air
7. Combustion fan (3" connection)
8. Glass air wash
9. Heat exchanger

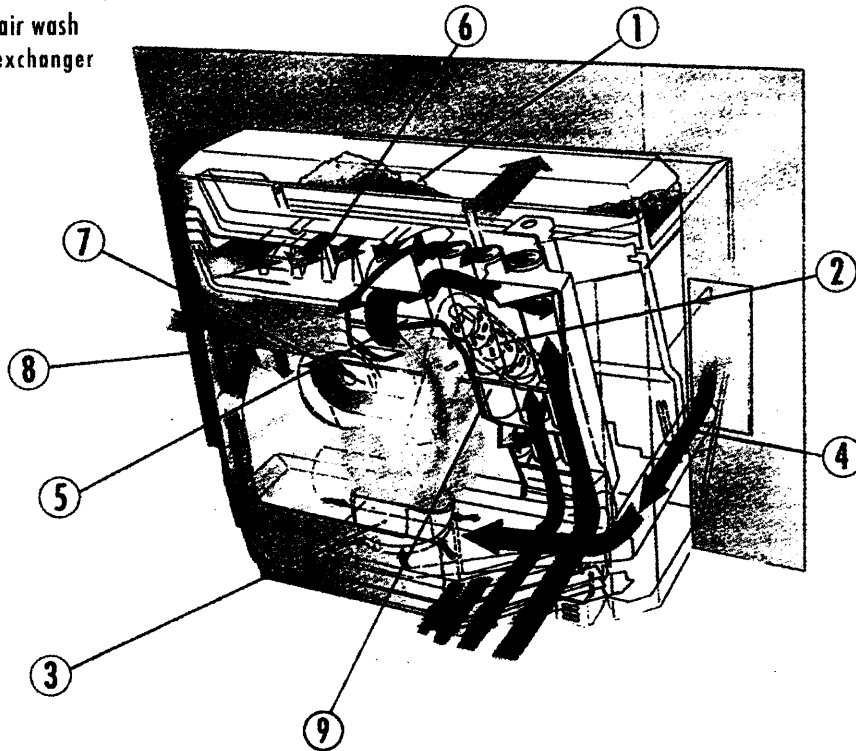

The technological superiority of your new pellet stove is the result of years of testing in the lab and in the field. The results are convincing: briefly put, the Integra pellet stove offers the following practical advantages:

USER FRIENDLY:

The electronic digital "brain" of the stove controls and monitors the interplay of combustion fan, auger speed, convection fan, and temperature control systems.

This control system reduces operator involvement to a minimum while at the same time maintaining maximum operational safety.

VERY QUIET OPERATION:

With the help of numerous tests in the acoustics lab, we succeeded in holding noise emissions from your Austroflamm Integra pellet stove down to a mere whisper, making it **the most quiet** stove on the market.

ENVIRONMENTALLY FRIENDLY:

Because of its large heat exchanger surface, a continuously monitored combustion air to fuel ratio (see  Electronic Air Sensor), and a fire pot, designed with function and ease of operation in mind, the Integra operates at peak efficiency and is environmentally friendly.

THE AUSTROFLAMM EXCLUSIVE PATENTED „ELECTRONIC AIR SENSOR“ SYSTEM FOR PELLET STOVES

WHAT YOU GET

1. Altitude compensation: Stove automatically compensates for air density, i. e. altitude above sea level.
2. Efficiency: Combustion air is electronically regulated for maximum efficiency according to temperature of incoming air.
3. Fuel consumption: At each infinitely variable heat setting, combustion air and convection air are perfectly matched according to the quality and quantity of fuel used.
4. Clean: Fresh intake air and expelled waste gases are automatically and continually monitored to determine optimum combustion efficiency. The combustion is perfectly balanced at all heat settings and levels of fuel consumption, exhaust emissions are at an absolute minimum.
5. Heat output: Because the stove is continually self-regulating for optimum combustion efficiency, the maximum possible heat output per pound of fuel used is achieved and constantly maintained.
6. Minor leaks in the stove's operating system, such as air flow passages, combustion chamber, door gaskets, or stove body, are automatically compensated for at all times.
7. All operating systems of the stove, including the combustion process, are constantly regulated and adjusted according to specific line voltage available. Any voltage drop is automatically and immediately compensated for.

HOW IT WORKS

1. The incoming fresh air to the stove is measured by the "cooling effect" this air flow has on an electrical resistor, located inside the two inch air intake duct. The resistance measured by this electronic air sensor determines the volume and density of the air entering the stove's combustion area. This volume is then compared to the nominal value. If the actual value does not equal the nominal value, the control board will slowly (within two minutes) adjust the combustion fan to achieve the nominal value.
2. Further upstream from the actual air speed/density indicator is a temperature sensor. Here different air temperatures, from -4°F to $+122^{\circ}\text{F}$ as well as relative humidity are compensated for. The lower density of the air at higher-than-sea-level conditions allows for less cooling of the electronic air sensor. Therefore, the combustion motor will automatically speed up until the amount of oxygen for combustion is the same as at sea level.
3. The nominal value (set point) of the air/fuel ratio is an optimum setting determined in the laboratory.

No user should ever disturb this optimum adjustment once it leaves the factory!



The detector element of the air sensor has to be cleaned once a year by a qualified service technician to guarantee problem-free operation of the stove.

CONTROL PANEL FUNCTIONS

1. POWER KNOB

The power knob allows adjustment of the stove's heat output into the room (except during the start cycle). The power knob is infinitely variable from low to high and simultaneously adjusts blower speed, fuel feed, and convection air. The control board automatically sets the optimum ratio of fuel to air for each infinitely variable setting from low to high, based on a performance curve preset at the factory. If the stove is operated with the optional thermostat, the power knob is used only to choose a range of operation. The optional thermostat allows the stove to switch between a high-heat setting (DEMAND) and a low setting (PILOT). While in the PILOT mode, the stove automatically adjusts itself to 50% of the power selected.

2. AUGER LIGHT

The red light on the control panel will flash on, whenever the auger is in actual operation, feeding pellets to the combustion chamber.

3. FUEL SWITCH ON/OFF

The fuel on/off switch allows power to be sent to the auger fuel feed motor under the proper conditions. When the on/off switch is turned to the "off" position, pellets will no longer be fed to the combustion pot, but the combustion and convection blowers will continue to operate until the stove has cooled down to a sufficiently safe level (approximately 45 minutes). Once the cooling down process is completed, the stove will automatically shut itself off. As a safety feature, if the exhaust temperature in the flue does not reach 140° within 15 minutes of burning, the stove will automatically shut itself off.

4. ROOM CONVECTION AIR

The power knob on the control panel controls the speed of the convection air fan. Convection air is taken in at the bottom of the stove, passed through a highly efficient heat exchanger inside the stove, and forced back out into the room through the fins at the top of the stove. At all settings between low and high or any setting in between, the fuel feed will automatically be adjusted to the optimum level of fuel use, according to the amount of convection air that is desired.

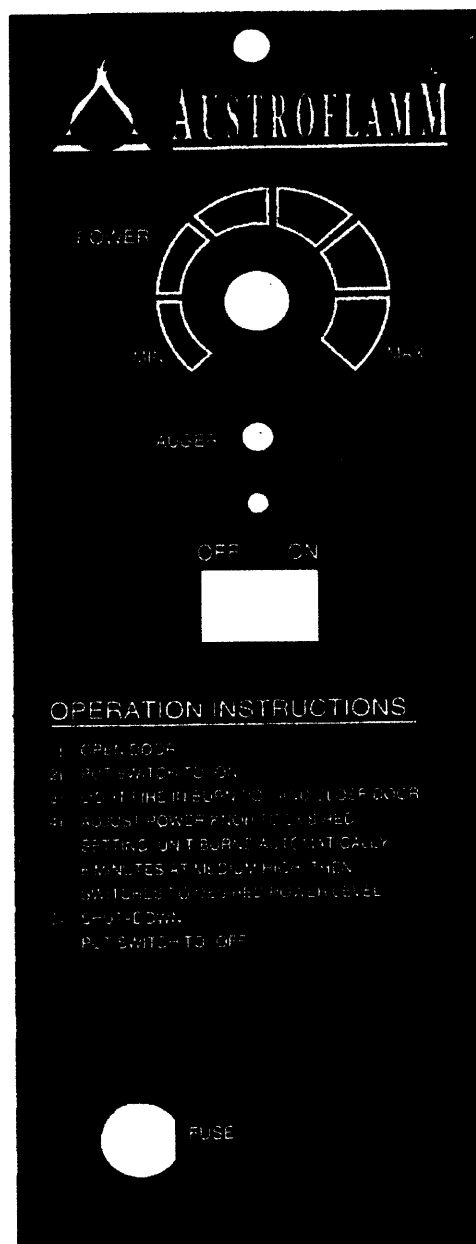

HOW TO START YOUR FIRE

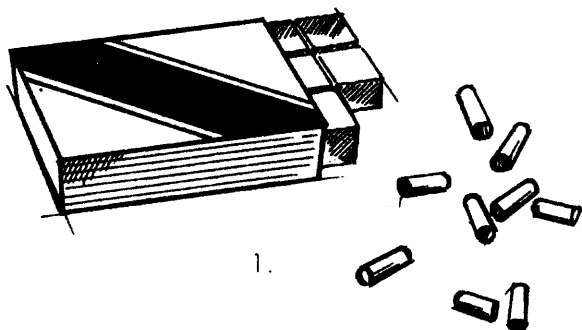

1. Check to make sure the hopper is filled with pellets and that the combustion pot is clean and free of all debris. Place a small handful of pellets in the burn pot and add the appropriate amount of approved fire starter. Stir together.

Please note: Flammable liquids should never be used to start your stove!

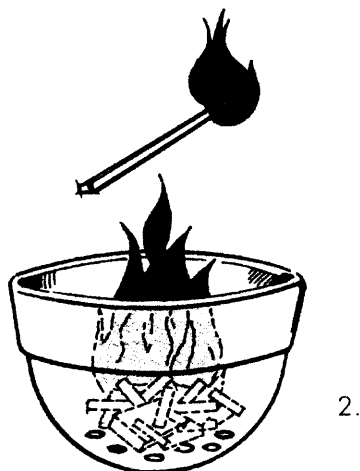

2. Light the fire starter in the pot with a match and close the door carefully. Push the "On/Off" switch to "On". This activates the fuel feed. When the hopper of the insert is filled for the first time, pellets will not feed into the fire pot for approximately 10 minutes. In this case it may be necessary to repeat the above process.

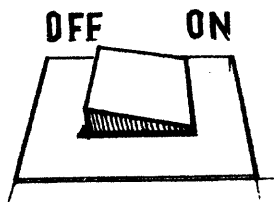

3. Adjust power knob. Unit will burn 8 minutes (auto control) then automatically will switch to desired power level.



NOTE
The burn rate will vary with different sizes of pellets. The larger the pellets, the slower they will feed and vice versa.



HINT
The Integra pellet insert may be safely operated on a continuous basis, but it is recommended that it be turned down overnight or when the room is vacated for long periods of time.

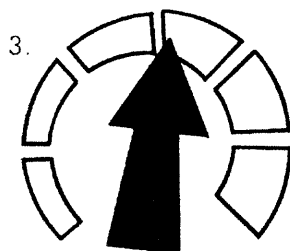

auto control

The Integra series pellet stove burns approximately 5.8 lbs./hour on "high" and approximately 1.1 lbs./hour on "low", depending on the type of pellets used.



HINT
If there are any questions, please contact your AUSTROFLAMM dealer.

ADDING FUEL

It is recommended that the hopper level be properly maintained so that the fire does not inadvertently go out due to lack of fuel. A 40-lb bag of fuel can be added to your AUSTROFLAMM Integra any time the hopper level is below half full. Check often, but keep hopper lid closed at all times, except when refilling.

Hopper capacity Integra insert:
99 lbs.

Hopper capacity Integra FS:
114 lbs.

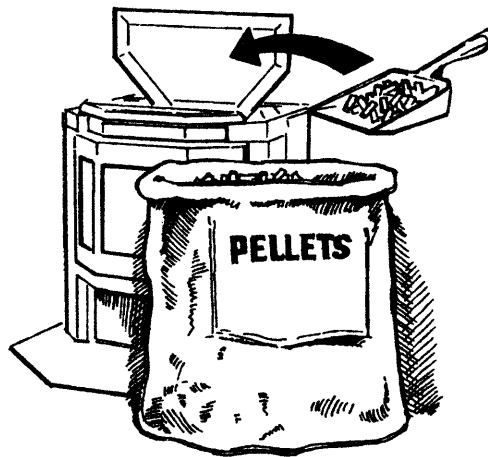

SWITCHING OFF YOUR PELLET STOVE

NOTE
Your Austroflamm pellet stove has built-in safety features to prevent overheating in case of malfunction. It is therefore necessary to remember that these safety features can not work if the stove is unplugged.

Turn the „On/Off“ switch to the „Off“ position. This will turn the auger motor off, and pellets will stop feeding. Both blowers will continue to operate for a period of time (up to 45 minutes) until the exhaust temperature cools down sufficiently. The blowers will automatically turn off after this period of time.

AUSTROFLAMM Maintenance Tool

The AUSTROFLAMM maintenance tool is nicknamed the „cold hand“. Use this tool instead of your hands when performing certain maintenance functions, such as:

1. Cleaning the heat exchanger tubes;
2. Cleaning the combustion pot;
3. Stirring pellets in the hopper if they become hung up on the sloped side walls.

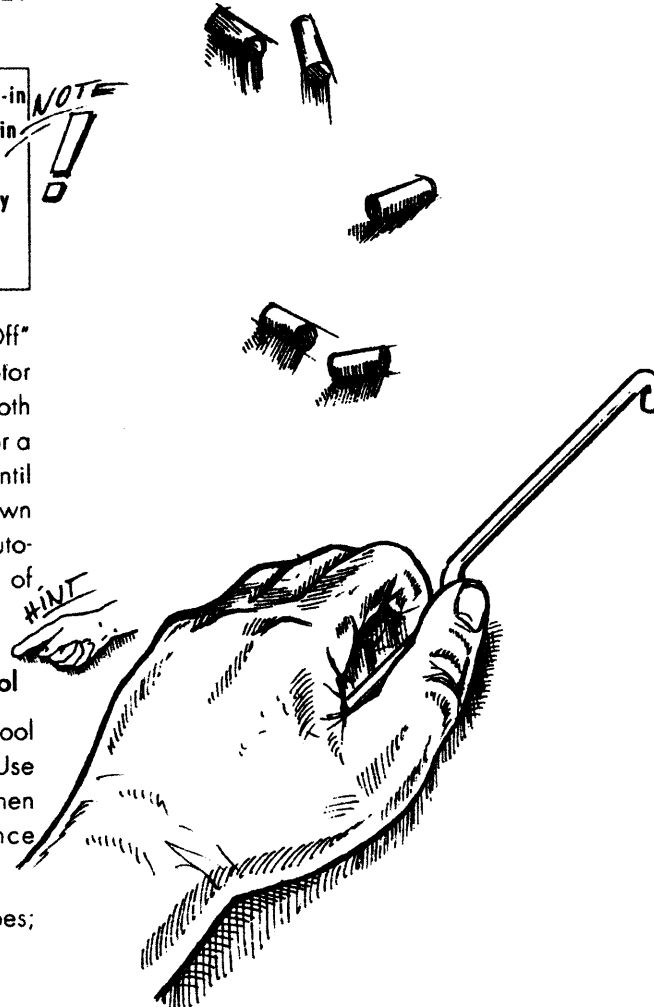

AUTOMATIC SAFETY FEATURES

1. Power outage

During a power outage, the stove will shut down automatically. If the outage lasts only a few seconds (15 seconds or less), the stove will restart. If it lasts longer (10 minutes or more), the stove blowers will restart, but the fire will not relight.

In the event of a power failure, a small amount of smoke may leak from the top of the window glass, the hopper, and from the combustion air intake (if it is not vented to the outside). This will not persist for more than 3 to 5 minutes and will not be a safety hazard.

2. Overheating

A high temperature switch will automatically shut down the stove in the event of overheating. For safety reasons, each motor also has an automatic high-temperature switch which turns the motor off if overheating occurs. The stove will have to be manually relighted. Let the stove cool for at least 45 minutes before restarting.

ROUTINE MAINTENANCE

UNPLUG STOVE BEFORE PERFORMING ANY MAINTENANCE WORK!

The amount of fly ash building up in your stove is directly proportional to the ash content of the fuel you are using (see page 16). Stove cleaning and maintenance frequency depends on the fuel you are using.

After a period of time (a week or so), clean the heat exchanger tubes, inspect the fire pot and ash pan. You will want to gauge your routine maintenance accordingly.

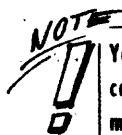

NOTE Your stove must be shut off and should be cool enough to handle before routine maintenance is performed.



HINT Note: All motors are sealed ball bearing systems. No lubrication is required.

1. COMBUSTION POT

The combustion pot should be inspected periodically to ensure that the air holes have not become clogged with ash or clinkers. The combustion pot can be easily cleaned in the stove, or it can be removed from the combustion chamber for cleaning.

2. STAINLESS STEEL HEAT EXCHANGER TUBES

Directly behind the top warming tile are two rods which are used for cleaning the heat exchanger tubes.

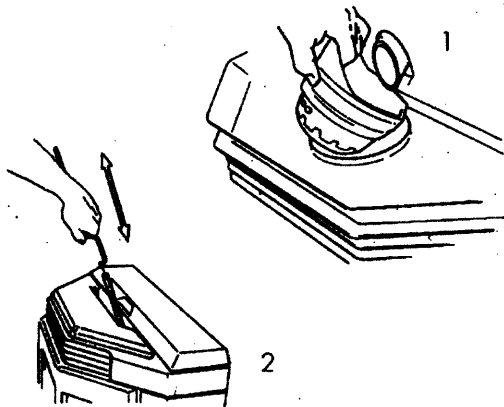

ROUTINE MAINTENANCE

By pulling these rods up and down several times you will clean the fly ash off the heat exchanger tubes and allow a more efficient heat transfer.

Keep the door closed, and turn the power knob to "low" during this operation.

Caution: The rods may be hot, and only the AUSTROFLAMM maintenance tool provided with the stove should be used for this process, as shown in diagramm 2 (page 23).

The heat exchanger tubes should be cleaned after every two days of use, or more frequently, if lower quality fuel is used! This is important to have the stove operate at maximum efficiency at all times.

Every two months of use: Remove the lower back wall panel of the fire box to vacuum the accumulated fly ash in the space between the heat exchanger tubes (2.1).

3. ASH PAN

The ash pan will have to be emptied as necessary. Remove ash pan only when stove is turned off and cooled down.

Caution: Dispose of and store ashes only in a steel container with a tight-fitting lid. Place container only on non-combustible surfaces.

4. DOOR ROPE GASKET

The condition of the rope gasket around the door and windows should be checked periodically. Replace or repair as necessary.

5. CHIMNEY

Inspect and clean the chimney frequently (once a year or more). Fly ash build-up may affect the performance of the stove and may be a safety hazard.

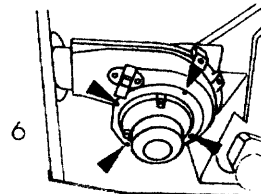
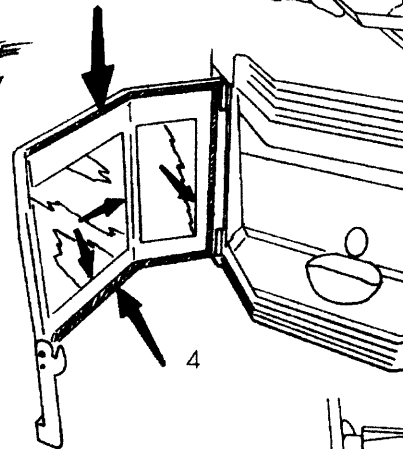
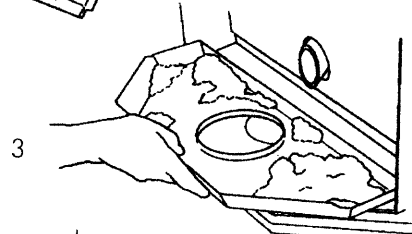
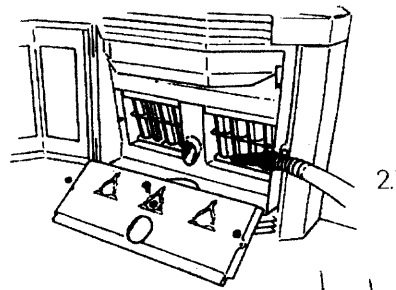

6. EXHAUST VENT HOUSING

This should be done once a year or more, depending on stove use and fuel quality.

Note: Do not undertake this procedure unless unit has been unplugged.

To inspect and clean the exhaust vent housing, remove four screws (as shown) and carefully pull out the motor. Vacuum fly ash from motor and inside exhaust vent and duct.

7. AIR SENSOR

The detector element of the air sensor has to be cleaned once a year by a qualified service technician to guarantee problem-free operation of the stove.

TROUBLESHOOTING GUIDE

PROBLEM

Fire burns with a lazy, orange flame. Pellets build up in the pot, and the window gets sooted up.

Cause:

1. Insufficient combustion air

Solutions:

1. Remove any clinkers or ash, which might be obstructing the primary air holes, from the bottom of the pot. Change to a better grade of fuel, if necessary.
2. Check that heat exchanger tubes are not clogged with ash.
3. Check for blockage in the air inlet duct or exhaust pipe.
4. Check gasket around door for leaks.
5. Check combustion blower impeller by removing the blower.
6. Clean impeller or remove blower for further service, if necessary.
7. Adjust combustion air trim up.

PROBLEM:

Fire goes out, or stove shuts down automatically.

Cause(s):

1. Hopper is empty
2. Pellets not feeding.
3. High-limit temperature switch has been tripped.
4. Fuel feed rate too low.
5. Door not sealed or not closed tightly.
6. Bad fuel quality.
7. Low-limit temperature switch has been tripped.
8. Faulty air sensor.

Solutions:

1. Refill hopper

2. See „Pellets Will Not Feed”, below.
3. Allow stove to cool for one hour and relight.
4. See „Routine Maintenance”.
5. Call your authorized AUSTRO-FLAMM dealer to adjust fuel control.

PROBLEM:

Pellets will not feed.

Cause(s):

1. Hopper is empty.
2. Auger, circuit board or relay may be defective.
3. Stove door open.

Solutions:

1. Check hopper contents. Add pellets, if necessary.
2. Have your certified AUSTRO-FLAMM dealer diagnose the problem and replace parts.

PROBLEM:

Stove runs for 15 minutes and then shuts down.

Cause(s):

1. Exhaust gas is not up to temperature.
2. Low-limit switch may need to be replaced.
3. Wires to either the low-limit snap switch or high-limit snap switch may be loose or disconnected.

Solutions:

1. Relight stove, if necessary.
2. Have a certified AUSROFLAMM dealer replace the low limit switch.

3. Check wiring, refer to service manual. Make sure there are good connections between the wires and their terminals.

PROBLEM:

Blowers will not shut off after the fuel has been switched off and the stove has cooled down.

Cause(s):

1. Low-limit snap switch has failed in the closed position.

Solutions:

1. Replace the low-limit snap switch or contact your Austroflam dealer.

PROBLEM:

Blowers will not operate.

Cause(s):

1. No power to stove.
2. No power to control board.

Solutions:

1. Check to see that the stove is plugged into the wall outlet. Check to see if your circuit board breaker has „tripped“.
2. Check wire connections.
3. Check fuse on control panel.

PROBLEM:

Soot or fly ash in the house.

Cause(s):

1. Cleaning the window, particularly when the stove is operating.
2. Leakage at the joints between the combustion fan, exhaust pipe, and „PL“ vent. This will be evidenced by dust on the impeller of the convection fan and in the heat exchanger tubes, or by ash on the floor behind the stove.

Solutions:

1. Shut down stove before cleaning to prevent dispersion into the room.
2. Seal up any leaks in the exhaust system with RTV high-temperature silicone sealer.

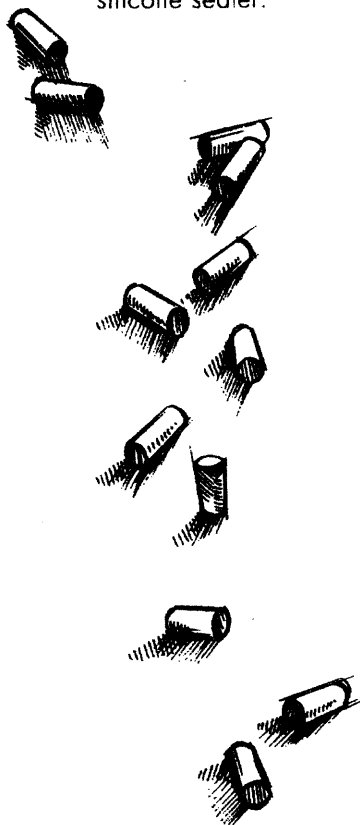

WARRANTY

The Manufacturer provides a five-year limited warranty on all steel parts (except the fire pot), and a one-year limited warranty on all electrical components. These warranties commence on the date of the original

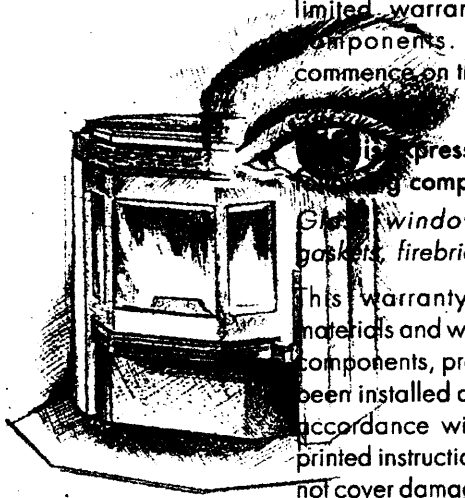

There is expressly no warranty on the following components:

Glass window, fiberglass rope gaskets, firebrick, paint, and tile.

This warranty covers defects in materials and workmanship in covered components, provided the product has been installed and operated strictly in accordance with the Manufacturer's printed instructions. This warranty does not cover damage or breakage caused by improper handling, misuse, or unauthorized modification. Without limiting the foregoing, the use of fuels other than pelletized wood will void all warranties and liabilities.

All claims under this warranty must be made in writing to:

AUSTROFLAMM
2210 Alexander Street
Salt Lake City, Utah 84119

INCLUDE:

1. Name, address, and telephone number of purchaser.
2. Name, address, and telephone number of seller, date of purchase, and proof of purchase.
3. Name, address, and telephone number of installer and date of installation.
4. Serial number of stove.
5. Nature of defect, malfunction, or complaint.

Arrangements will be made for inspection. If the inspection indicates that the failure was due to defective material or workmanship in covered components and that the other terms and conditions of this warranty have been complied with, the Manufacturer's sole duty and liability under

this warranty shall be limited to the Manufacturer's replacement or repair, at Manufacturer's option, of the defective unit or part. The purchaser shall assume all costs of shipping to and from the Manufacturer or his agent and shall be responsible for all losses incurred during shipment. Removal and reinstallation costs are not covered under this warranty. Neither the Manufacturer nor the supplier to the purchaser accept responsibility, legal or otherwise, for incidental or consequential damage to property or persons resulting from the use of this product. Any warranty implied by law, including, but not limited to, implied warranties of merchantability or fitness, shall be limited to one year from the date of the original purchase.

Whether a claim is made against the manufacturer based on a breach of this warranty or any other type of warranty, expressed or implied by law, the Manufacturer shall in no event be liable for any special, indirect, consequential, or other damages of any nature whatsoever in excess of the original purchase price of this product. All warranties by the Manufacturer are set forth herein, and no claim shall be made against the Manufacturer based on any oral warranty or representation.

Some states do not allow the exclusion or limitation of consequential damages or limitations of implied warranties, so the limitations or exclusions set forth in this warranty may not apply to you.

WARNING

Changes to the design characteristics or operating parts are not authorized by the Manufacturer and will void any and all warranties. Such changes may create hazardous conditions which can endanger the user and/or his property.

This warranty gives you specific legal rights, and you may also have other rights which vary from state to state.