

Ricoh Shotmaster

Ultra Zoom Super

This camera manual library is for reference and historical purposes, all rights reserved.

This page is copyright by mike@butkus.org, M. Butkus, NJ.
This page may not be sold or distributed without the expressed permission of the producer.
I have no connection with Chinon Co., Japan

On-line camera manual library

This is the full text and images from the manual. This may take 3 full minutes for all images to appear. If they do not all appear. Try clicking the browser "refresh" or "reload button" or right click on the image, choose "view image" then go back. It should now appear.

To print, try printing only 3 or 4 pages at a time.

[Back to main on-line camera manuals page](#)

**If you find this manual useful, how about a donation of \$3 to:
M. Butkus, 29 Lake Ave., High Bridge, NJ 08829-1701**

**This will allow me to continue to buy new manuals and pay their shipping costs.
It'll make you feel better, won't it?**

If you use Pay Pal, use the link below. Use the above address for a check, M.O. or cash.

Venmo is @mike-butkus-camera



www.PayPal.me/butkus



CONTENTS

Locating the controls	16	Flash photography	23
Main Features :	17	Auto backlight control/Auto fill flash	23
Before using	17	Using the self-timer	24
Attaching the strap	17	Creative modes :	24
Inserting the battery	17	Red eye reduction mode	25
Opening the viewfinder cover	18	Flash-off mode	26
Checking the battery	18	Flash-on mode	26
Loading the film	19	Super night mode	27
Setting the film speed	20	Continuous shooting mode	28
Holding your camera	20	TV mode	29
Viewfinder	20	Panorama pictures	29
Zooming the lens	21	Electronic remote control socket	30
Auto-focus shooting	21	(Optional) Databack settings	31
Pre-focus shooting	22	Proper care of your camera	33
Auto film rewinding	23	Major specifications	34

We are most gratified that you have selected a RICOH camera. Before using your camera, please be sure to read these instructions carefully.

LOCATING THE CONTROLS

1. Mode Button

2. LCD Panel

3. Zoom Switch

4. Shutter Release Button

5. Remote Control Socket

6. Strap Holder

7. Lens

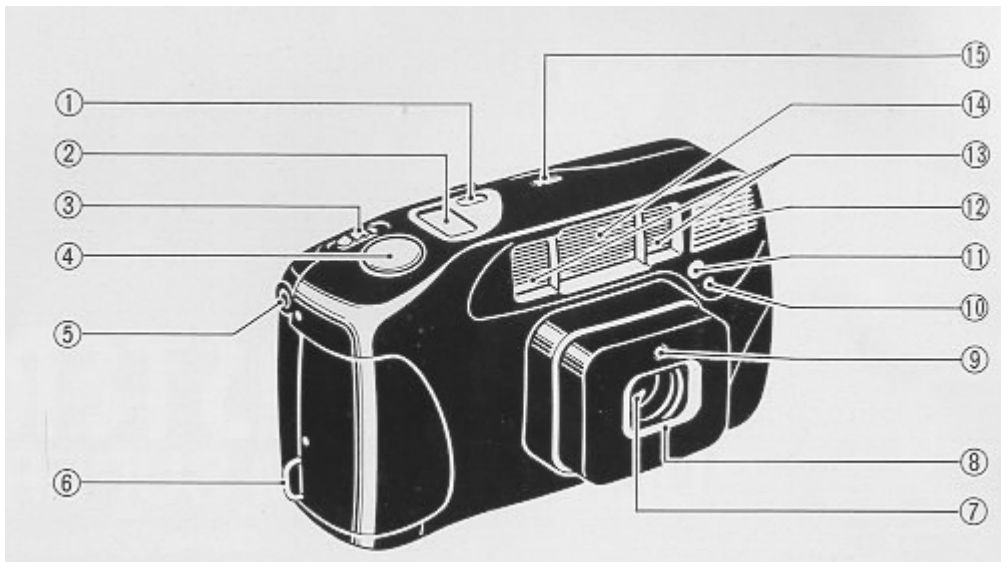

8. Lens Shield

9. Photocell

10. Self-timer LED

11. Red Eye Reduction Lamp

12. Built-in Flash

13. Distance Measuring Window

14. Viewfinder Window

15. Self-timer Button

16. Viewfinder	25. Battery Compartment Cover Latch
17. Viewfinder Cover	26. Battery Compartment Cover
18. Film Take-up Spool	27. Film Cassette Chamber
19. Back Cover Latch	28. Film Loaded Window
20. Safety Lock	29. Back Cover
21. Tripod Socket	30. Sprocket
22. Film Guides	31. Panorama Switch
23. Film Rewind Gear	32. Flash Charge Monitor
24. Manual Film Rewind Button	33. AF Monitor

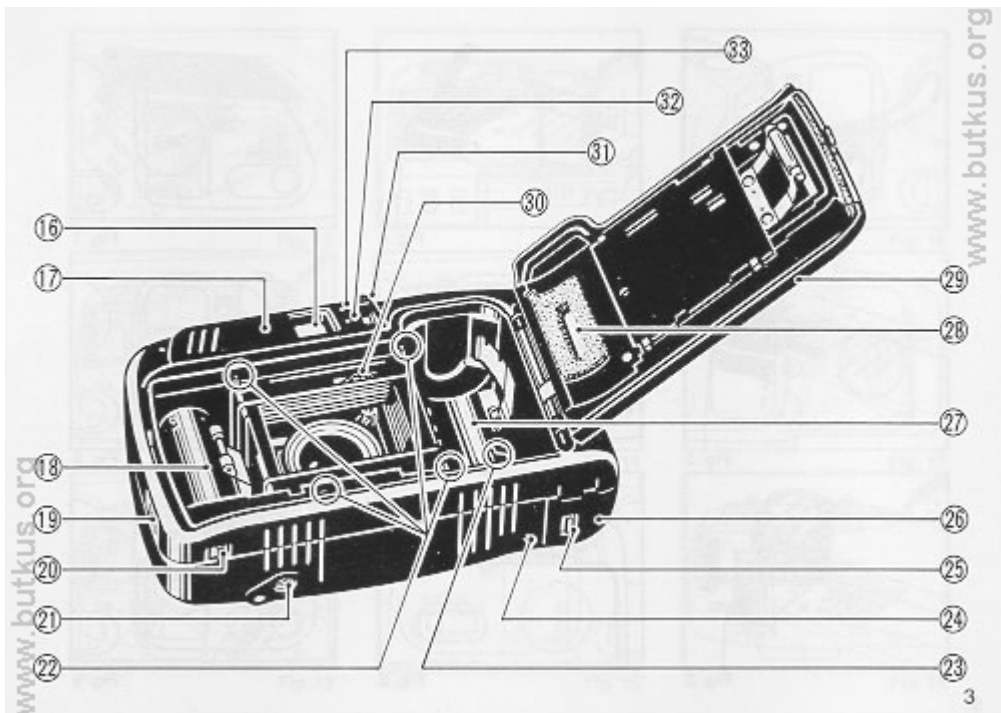

MAIN FEATURES

<ul style="list-style-type: none"> · light and compact with built-in 2x ZOOM lens · Safety Lock · Super Night Mode 	<ul style="list-style-type: none"> · Red Eye Reduction Mode · Switchable panorama (Mid-roll)
---	--

BEFORE USING

- A fast film such as ISO 200 or ISO 400 is recommended to prevent blurriness and to obtain a longer flash range.
- This camera has a high voltage circuit. Because it is dangerous, **DO NOT ATTEMPT TO TAKE CAMERA APART.**
- Do not hold the lens part of the camera.
- Before taking important pictures (at weddings, on trips abroad, etc.) test the camera to see how it works.

ATTACHING THE STRAP

1. Insert the small loop at the end of the Strap under the Strap Holder. **(Fig. 1 (1))**
2. Insert the other end of the Strap through the loop to tie the Strap onto the Strap Holder. **(Fig. 1 (2))**

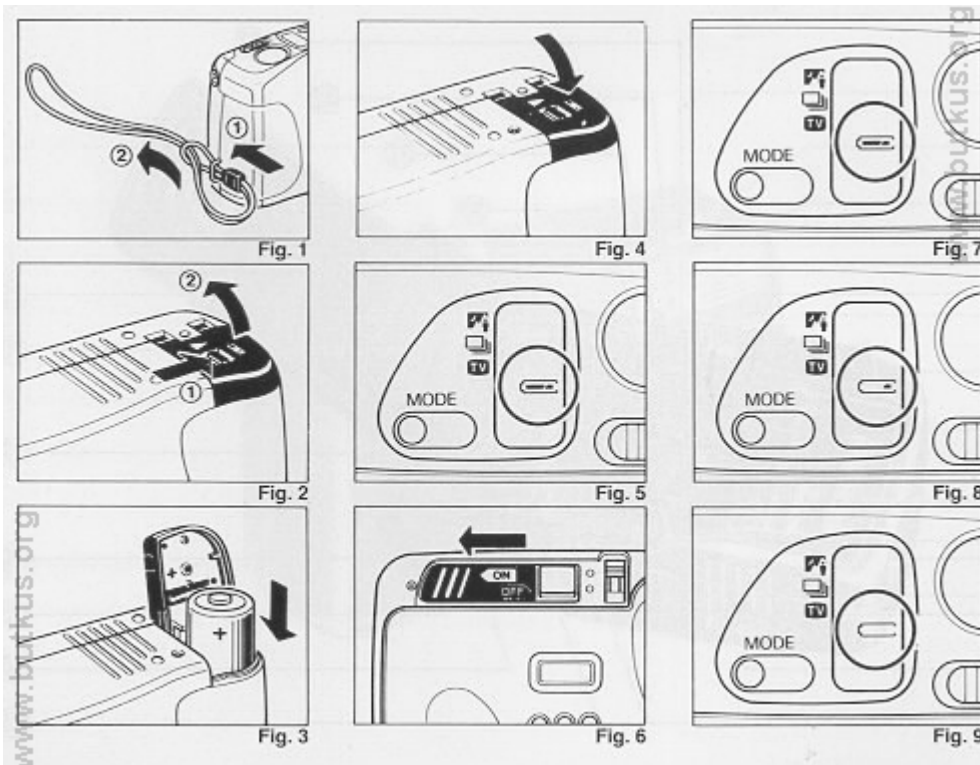

INSERTING THE BATTERY

The camera will not operate unless the battery is installed. It is important to make sure that the battery is installed correctly.

1. Use a pen to push the Battery Compartment Cover Latch in the direction of the arrow and pull open the cover. **(Fig. 2)**
2. Insert the recommended 3 volt lithium battery, contact end first, checking that the + and - on the battery are aligned according to polarity diagram inside the battery compartment. **(Fig. 3)**
3. Close the Battery Compartment Cover by pushing it in the direction of the arrow until it locks firmly in place. **(Fig. 4)**

* With the battery inserted correctly the Battery Condition Mark ~ appears on the LCD Panel when the Lens Shield is opened. **(Fig. 5)**

* Do not remove the battery from the camera until you are ready to replace it.

* When replacing the battery, do so as quickly as possible to Avoid erasing camera memory. We recommend replacing the battery when there is no film in the camera....

Recommended. Replacement 3 V Lithium Batteries Include:

Lithium battery (3V)
Panasonic CR-123A
Duracell XL DL-123A

OPENING THE VIEWFINDER COVER

1. Open the Lens Shield by sliding the Viewfinder Cover in the direction of arrow. **(Fig. 6)**

2. When the Lens Shield is opened, the lens emerges from its standby position to the ready position and the camera sets everything automatically.

* You can only take pictures when the Lens Shield is completely open.

* To avoid tripping the shutter inadvertently and wasting battery power, always keep Viewfinder Cover closed when you are not taking pictures.

* When the Viewfinder Cover is closed, all LCD indicators will disappear to conserve battery power.

CHECKING THE BATTERY

1. The on symbol is displayed on the LCD Panel when battery power is sufficient. **(Fig. 7)**

2. When the battery is nearly exhausted, the ~ symbol will appear. **(Fig. 8)** Replace with a new battery as soon as possible. (Use of the flash at this time is not recommended.)

3. When the battery is completely exhausted, the c symbol will be displayed. **(Fig. 9)** Replace with a new battery.

* In extremely cold temperatures, the battery mark may display then symbol. (In cold temperatures, the battery voltage is reduced.) You may be able to use the camera if you remove the batteries and warm them up.

* If the battery voltage is insufficient, the shutter may not release or the film may not advance completely. In the following cases, replace the battery:

1) When the battery mark displays the "empty battery" symbol.

2) When the shutter does not release....

3) When film advance and rewind cannot be done.

4) When the self-timer does not function.

LOADING THE FILM

Always avoid direct sunlight when loading the film.

1. Push the Back Cover Latch Downward to open.

* When the Safety Lock on the bottom of the camera is in the "on" position, the back cover cannot be opened. Slide the lock to the "off" position to open the back cover. **(Fig. 10)**

2. Load the film cassette into the Film Chamber and pull out enough film leader to extend past the mark of the film leader position. **(Fig. 11, 12)**

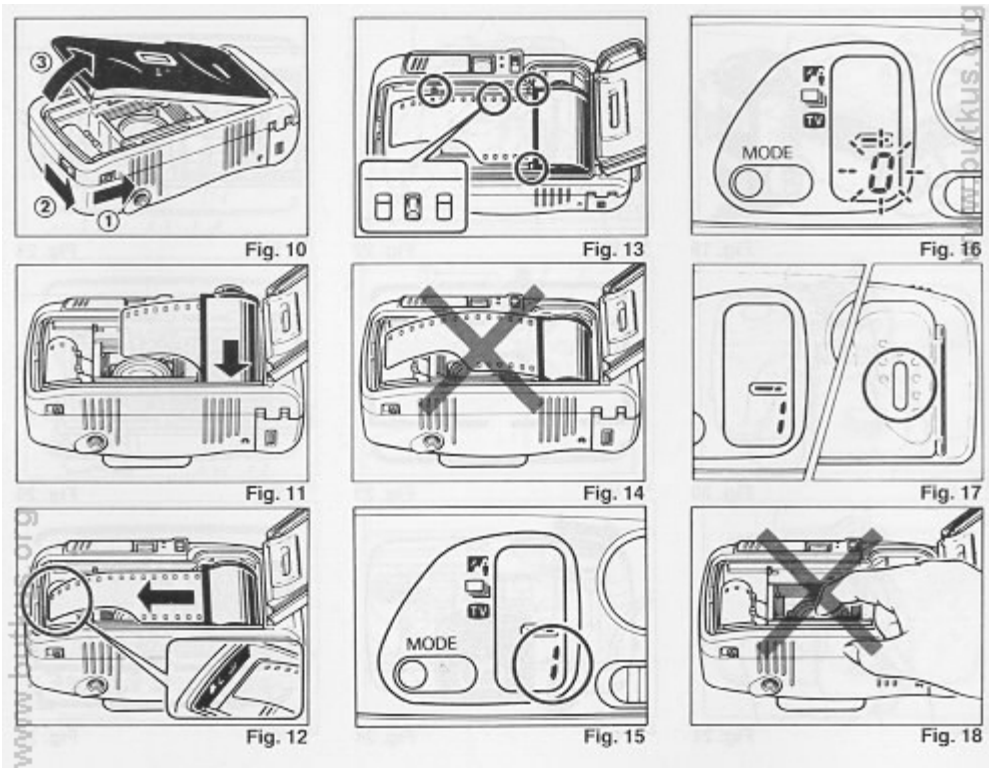

* If there is any dust on the inside lens surface, use a blower to blow the dust away.

3. Make sure the film stays within the Film Guides and lies flat. **(Fig. 13,14)**

4. Press the Back Cover shut so that the Back Cover Latch returns to its original position. The film is automatically advanced until number "1" appears in the LCD Panel. As soon as you close the Back Cover, the LCD Panel should confirm proper loading with the Exposure Counter. **(Fig. 15)**

5. If the film has not advanced correctly and is not taken up onto the Film Take-up Spool, the Exposure Counter will blink. **(Fig. 16)** The shutter release will also lock so you cannot take a picture until the film is loaded properly. (DX Film only)

Reload the film by following steps 1 - 4 shown above.

* We recommend that you use the Safety Lock to prevent the Back Cover from opening accidentally during use.

* Whether there is film in your camera or not can be confirmed by either the Film Loaded Window or the Exposure Counter in the LCD Panel. **(Fig. 17)**

* You can confirm that the film-wind or rewind is working properly by observing the Exposure Counter.

* You can load film in your camera with the Lens Shield closed. However, the loading sign will disappear after about 3 sec.

* Do not touch the inner lens with your fingers or the edge of film. (Fig. 18)

SETTING THE FILM SPEED

DX-coded film cassettes have black-and-silver patterns corresponding to film speeds that the camera reads and automatically sets. Your camera accepts DX films with speeds ranging from ISO 64 to 3200. Before loading your film, please check whether the cassette is DX-encoded or not. **(Fig. 19)**

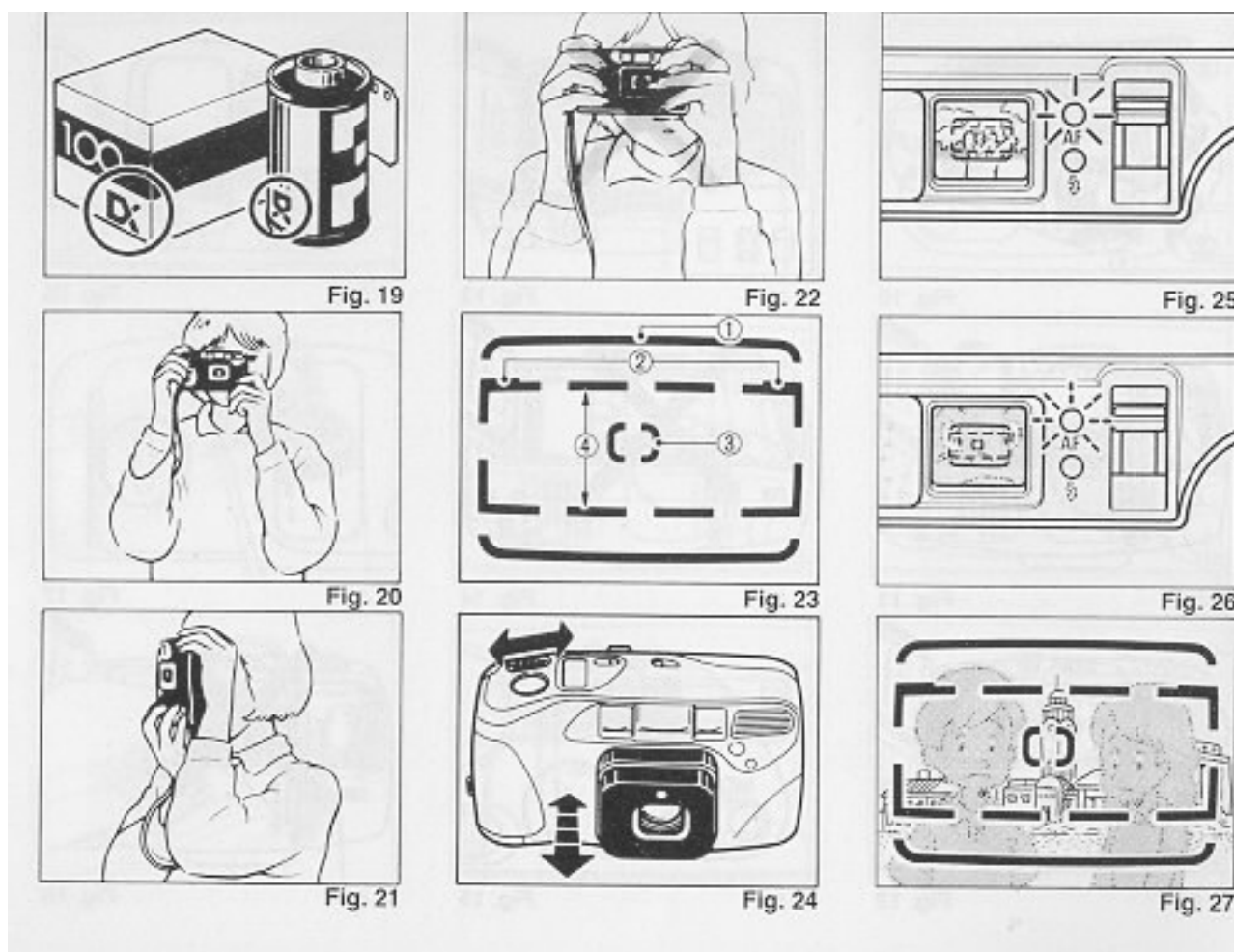

When using DX coded films, setting the film speed is not necessary. Your camera automatically sets the correct film speed.---

When using a film without DX code, your camera will automatically set itself to ISO 100.

HOLDING YOUR CAMERA

1. Always use both hands to steady your camera. **(Fig, 20)**

* When holding the camera vertically always position it with the flash at the top. **(Fig. 21)**

* Be careful not to place your fingers over the lens, flash or focusing windows. **(Fig. 22)**

* We suggest that you become familiar with your new camera by shooting and processing at least one roll of film before using your camera to record an important occasion.

* If the camera moves during the exposure, the whole picture will be blurred. To take clear pictures, hold the camera steadily and properly.

VIEWFINDER (Fig. 23)

1. Field of View Frame:

The subject (such as people or scenery) you wish to photograph should be set within this frame.

2. Parallax Correction Marks: (Close focusing)

When taking a picture of a subject that is between 0.6 m--1.2 m away from your camera, the subject should be positioned within these marks. Anything outside the marks will not be included in the picture even if you can see it through the viewfinder.

3. AF Mark

In the AF mode the auto-focus system focuses automatically on any subject that appears within this small [] target.

4. Panorama Field of View Frame

When taking panorama pictures, set the subject within this frame.

ZOOMING THE LENS

The built-in 32 - 64 mm zoom lens lets you get closer to your subject without changing your position. This lets you

easily select the composition that best suits your subject. (**Examples 1, 2**)



To zoom the lens, just slide the zoom switch (**Fig. 24**) in either direction until your subject is framed properly

- * When zooming the lens, keep your fingers away from the moving lens components.
- * When closing the Viewfinder Cover, the lens will return to its storage position automatically.
- * After about 3 minutes, the lens will return to wide position and the display on the LCD panel will disappear...

AUTO-FOCUS SHOOTING

1. Set the subject you wish to take within the Viewfinder Frame. (**Fig. 25**)

2. If the subject is closer than 0.6 m the AF-Monitor will blink and the shutter will lock to prevent out of focus pictures. (**Fig. 26**)

- * Under certain unusual conditions, the AF Monitor may not warn when you are too close to the subject.

3. Press the Shutter Release Button gently to avoid camera shake. The film advances automatically after the shutter has been released.

- * Be careful not to accidentally cover the Auto Focus Distance Measuring Windows on the front of your camera, as this will cause incorrect focusing.

- * Keep the Auto Focus Distance Measuring Windows clean to ensure accurate focusing. If they get dirty, they should be wiped clean with a soft cloth.

- * There may be rare cases when accurate focusing is difficult or impossible. (For instance, with dark subjects that do not reflect light well, glossy subjects, or subjects taken through glass.) In these cases, it is best to use the Pre-

Focus technique to "lock" the focus on a more "normal" subject at the same distance. While holding focus, turn your camera back to the original subject and shoot. (See PRE-FOCUS SHOOTING (**Page 22**) for more details.)

PRE-FOCUS SHOOTING

When the main subject you wish to **focus on is not** within the Auto-Focus Frame, or if the subject is difficult to focus on, then you should use pre-focus shooting.

When the subject is not within the Auto-Focus Frame:

1. If you want to photograph two people, there may be cases where neither of them can be within the Auto-Focus Frame in the center of the Viewfinder. If you release the shutter then only the background will be in focus, and the people, who are the main subject, will be out-of focus. (**Fig. 27**)

2. Move the camera so that one of the people is within the Auto-Focus Frame.

Press the Shutter Release Button **halfway** so that the AF Monitor lights up. Hold your finger in that position on the Shutter Release Button. (**Fig. 28**)

3. Now return the camera to its original position so that both people are in the Field of View Frame again, and press the Shutter Release Button fully to take the picture. (**Fig. 29**)

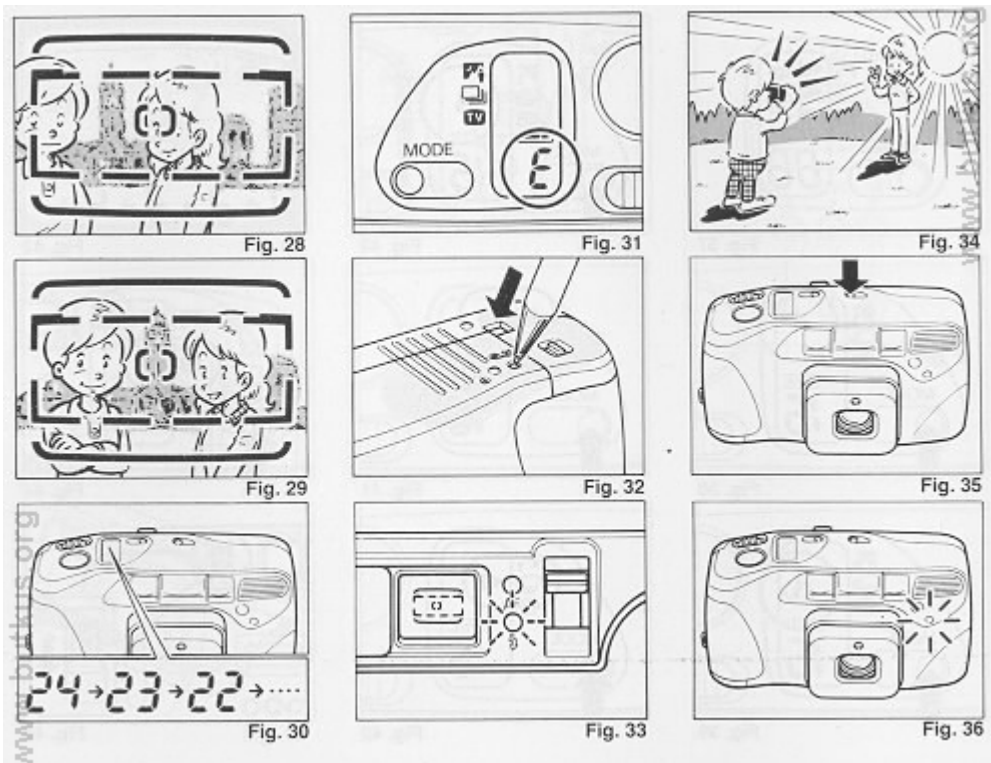

When the subject is difficult to focus on:

1. When you are photographing subjects that are difficult to focus on (such as a black dog **glossy** surface or behind glass), find another subject at about the same distance from the camera. You can pre-focus on that subject in the same way as described above.

If you are shooting through a window, aiming the camera at a slight angle to the glass usually avoids any direct reflection of auto-focus beam.

* When you remove your finger from the Shutter Release Button, the pre-focused condition is cleared, so that you can pre-focus again as many times as you wish.

AUTO FILM REWINDING

1. After the end of the film has been reached, the film will automatically rewind.
2. Film rewinding is indicated by the Exposure Counter and the counter counting backwards. **(Fig. 30)**
3. When the film is fully rewound, the motor stops automatically and "E" is displayed in the LCD Panel. **(Fig. 31)** Open the Back Cover to unload the film.

* When the Safety Lock is in the "on" position, the Back Cover will not open even if the Back Cover Latch is released. Move the Safety Lock to the "off" position.

* If you wish to rewind the film before reaching the end of the film, push the Manual Film Rewind Button with a pen, etc. **(Fig. 32)**

* The shutter release is locked with "E" displayed.

* Be careful not to touch the inner lens surface with your fingers or the edge of film.

FLASH PHOTOGRAPHY

1. If additional light is required, the built-in Flash automatically activates.

* Recommended Flash Shooting Range. (ISO 100)

Wide-angle: 0.8 m--about 3.9 m (2.6 ft. - 13 ft.) Telephoto: 0.6 m--about 2.1 m (2 ft. - 7 ft.)

(ISO 400)

Wide-angle: 0.8 m--about 7.8 m (2.6 ft. - 26 ft.) Telephoto: 0.6 m--about 4.2 m (2 ft. - 14 ft.)

2. When the flash is still charging, the Red Flash Monitor will blink and the shutter will be locked. **(Fig. 33)** Wait until RED-LED turns off in order to use the flash.

AUTO BACKLIGHT CONTROL/ AUTO FILL FLASH

When taking pictures of backlit subjects, important details are often lost in the shadows. Your camera automatically compensates for these lighting situations. If the subject is backlit and is at least about 2.5 m (8.2 ft.) from the camera, Auto Back-Light Control (ABLC) will be activated. If the subject is within about 2.5 m (8.2 ft.) of the camera, the flash activates automatically and the shadows are lightened up using automatic daylight fill-flash. Thus, with backlit subjects, natural-looking pictures can be taken easily and automatically. **(Fig. 34)**

USING THE SELF-TIMER

1. Compose your picture with the camera on a steady support.
2. Press the Self-timer Button. **(Fig. 35)** The Selftimer LED on the front of the camera will light steadily for approximately 8 seconds, then blink for about 2 seconds just before the shutter is released. **(Fig. 36)**

* If you wish to stop the self-timer once it has started close Viewfinder Cover or press the Self-timer Button again...

Using the Self-timer for Flash Photography:

When the Self-timer Button is pressed the built in Flash will fire automatically whenever there is insufficient light.

* You may not be able to activate the self-timer when the flash is just beginning to recharge. Wait 2 - 3 seconds and try again.

* If the distance between subject and camera is too close, the AF Monitor will blink. At that time, the self-timer will not activate. Move back a lime and try again.

* Too-Close Warning Lamp (AF Monitor) will blink only when pushing Self-timer Button and/or the Shutter Release Button.

Using the Self-timer for Pre-focus Photography:

- a. Select the subject you wish to pre-focus on. Move the camera so that it is in Auto-Focus Target.
- b. Press the Self-timer Button to lock-in the focus and reposition the camera if necessary.
- c. The self-timer activates and the focus will remain fixed at the locked-in distance until the photograph is taken.

CREATIVE MODES

This camera includes a variety of special operating modes which permit you to widely express your creativity. These modes include Red eye reduction, Flash-off, Flash-on, Super Night, Continuous and TV.

Many combinations may be made using these selections with flash photography, self-timer, and/or remote control picture taking, allowing you to fully and precisely obtain the image you seek. Try experimenting. These modes are designed to stimulate your imagination and creativity.

* To select operating modes, simply press the Mode Button next to the LCD Panel located on the top of the camera. You can confirm that the desired feature mode is in effect by checking the LCD Panel with  which displays the current feature mode. The symbols used for these modes are listed below. For detailed operation of each mode, refer to their respective sections in this manual.

Feature Mode Symbols (Fig. 37)

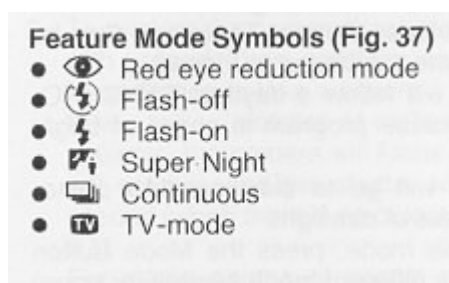

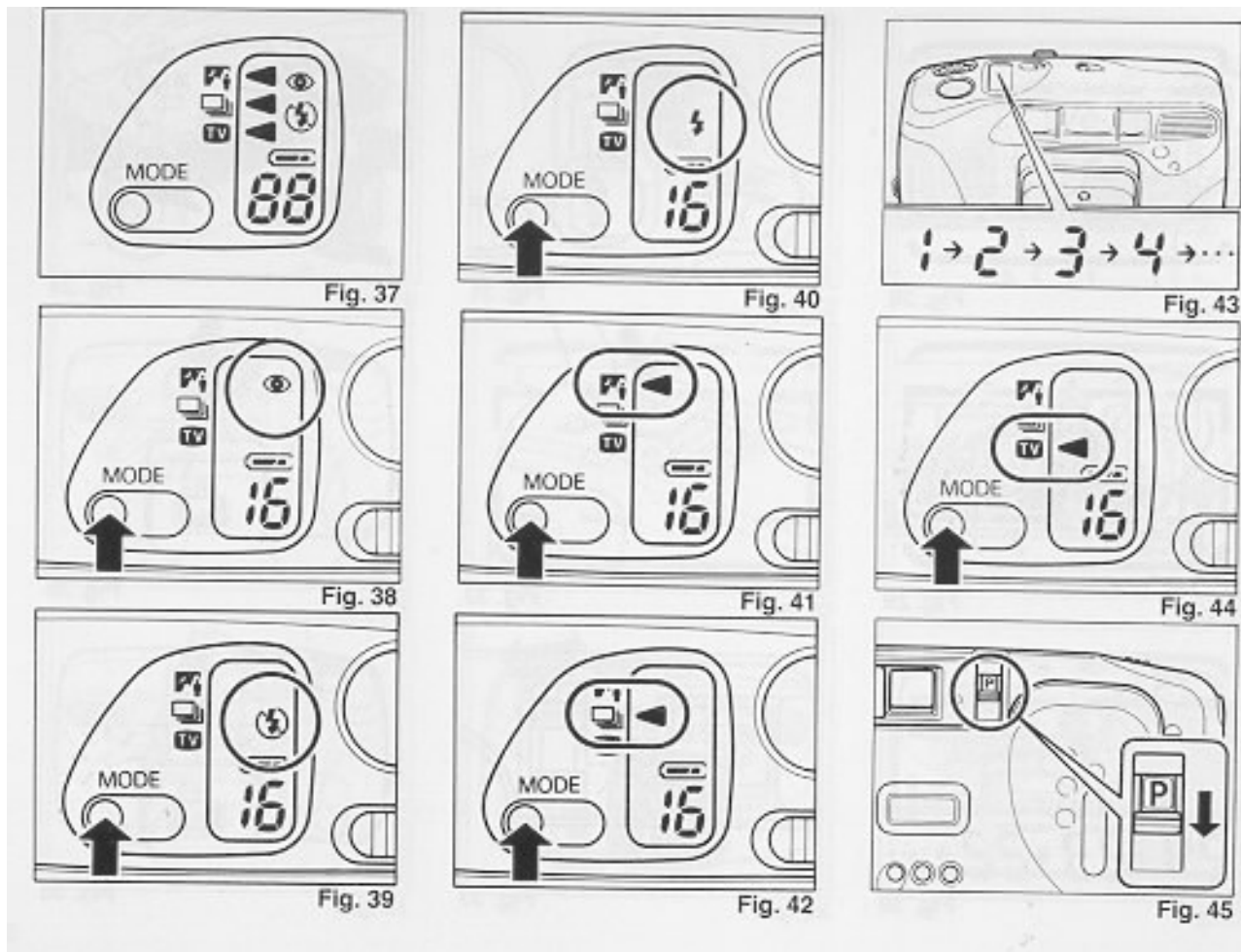

RED EYE REDUCTION MODE

Minimizing the Red-Eye Effect

Selecting this mode makes it possible to minimize the red-eye effect that sometimes occurs when taking portrait photograph. with flash. Now it's easy for anyone to take superior shots of people.

1. Press the Mode Button until the "  " symbol appears on the LCD Panel. **(Fig. 38)**

2. Press the Shutter Release Button. The lamp for red eye reduction will light. After a brief delay, the flash will fire, and the shutter will be released. The entire sequence will take about one second.

* Be sure to hold the camera still after pressing the Release Burton until full the cycle is complete and the shutter is released.---

* You may wish to your subjects to wait for complete above operation.

* This mode does not cancel when the viewfinder cover is closed. To cancel this mode, press the mode button again for any other selection.

FLASH-OFF MODE

This mode forcibly prevents automatic firing of the flash, thus allowing available light photography in museums, churches, etc. where flash photography is prohibited.

1. Press the Mode Button until the  symbol appears on the LCD Panel. **(Fig. 39)**
2. Press the Release Button and the shutter will be tripped without flash.

* To cancel this mode, press the Mode Button until there is a different mode symbol (or none) on the LCD Panel, or close the viewfinder cover.

* In dim light, the camera's shutter speed will be automatically reduced. To prevent a blurry picture, hold the camera steadily and press the Shutter Release Button gently.

FLASH-ON MODE

This forcibly trips the flash when you want to photograph subjects with sunlight to their side or back. It lets you take more natural looking pictures by softening harsh shadows.

Example 3: When the Flash-on mode is set

Example 4: When the Flash-on mode is not set

1. Press the Mode Button until the S symbol appears on the LCD Panel. **(Fig. 40)**
2. Press the Release Button. There will now be flash every time the shutter is tripped.

* The camera will follow a daytime SYNCHRO Sunlight Exposure program in cases of bright light

* The camera will go to slow synchro photography in cases of dim light.

* To cancel this mode, press the Mode Button until there is a different mode symbol (or none) on the LCD Panel, or close the viewfinder cover.

SUPER NIGHT MODE

With the **Super** Night Mode, beautiful pictures can be easily taken at night. The camera automatically selects the optimum settings for pictures of night scenery, pictures of people at night (slow synchro photography), and evening or day landscape pictures. **(Example5)**

1 When the Mode Button is pressed, ~ in the LCD Panel indicates the  mark. **(Fig. 41)**

2. To prevent the camera from moving, stabilize it with a tripod. Then, gently press the Shutter Release Button to take a picture.

When taking pictures of night scenery with no subjects, the camera will focus on GO The flash will not fire, and the shutter will open for one second (when there is no object within 6 m (19.7 ft.)).

For taking photos of people against a background of night scenery, the camera will first focus on x and open the shutter for 1 second without flash. After closing the shutter, the camera will then focus on the people and take another picture with the flash.

* By doing this, beautiful pictures of both the night scenery and people are possible. (The people have to be within 6 m (19.7 H.)).

* When taking pictures of landscapes in bright daylight, the camera will focus on oo and set itself to auto exposure.

If people are taken in bright daylight, the camera will set itself to daytime exposure program which will set flash off.

Reference:

* To prevent blurry pictures from slow shutter speeds, we recommend using a tripod and accessory cable release or remote electronic shutter.

* You may wish to advise your subjects not to move until flash fires, to prevent blurred pictures.

CONTINUOUS SHOOTING MODE

This mode allows you to shoot continuously as long as the shutter is pressed. You can accurately capture the continuous action such as competitive sport events, moving subject and even the movements of an infant without missing any important moments.

1. Press the Mode Button to set your camera in the Continuous Shooting Mode. Confirm that the ~ mark is indicated by  in the LCD Panel. **(Fig. 42)**

2. Press and hold down the Shutter Release Button. Your camera will continuously take pictures at a rate of one frame per second as long as the Shutter Release Button is held down. **(Fig. 43)**

3. Press the Mode Button to cancel the Continuous Shooting Mode...

* If you want to cancel the Continuous Shooting Mode before taking any picture, press the Mode Button again **until** the mode marks go off, or close the Viewfinder Cover.

Combining the Continuous Shooting Mode and the Self-timer:

1. Set your camera to the Continuous Shooting Mode.

2. Press the Self-timer Button. Your camera will wait 10 seconds, then shoot two sequential frames.

3. Push the Mode Button to cancel the Continuous Shooting Mode.

* Because the Auto-Focus adjusts with each exposure, be sure the subject is in the Auto-Focus Target to ensure that the focus will not be on any other object.

TV MODE

Use this mode to record your computer graphics or video images from the screen of a computer monitor or television.

1. Press the Mode Button until the HI mark is indicated by ~ in the LCD Panel **(Fig. 44)** Take the picture.

- * The Flash Unit will not activate in the TV Mode.
- * When taking pictures in TV Mode, the shutter speed will be set to 1/23 sec. and ISO will be reset to 100.
- * For TV Mode photography, slow-moving TV images will usually turn out clearer than fast-moving ones. Using a tripod and electronic cable release is recommended to prevent camera shake.
- * To use the self-timer in this mode, press the Mode Button until the camera is set to TV Mode, then press the Self-timer Button.
- * To cancel this mode, press the Mode Button until the LCD Panel shows a different mode symbol (or none), or close Viewfinder Cover.

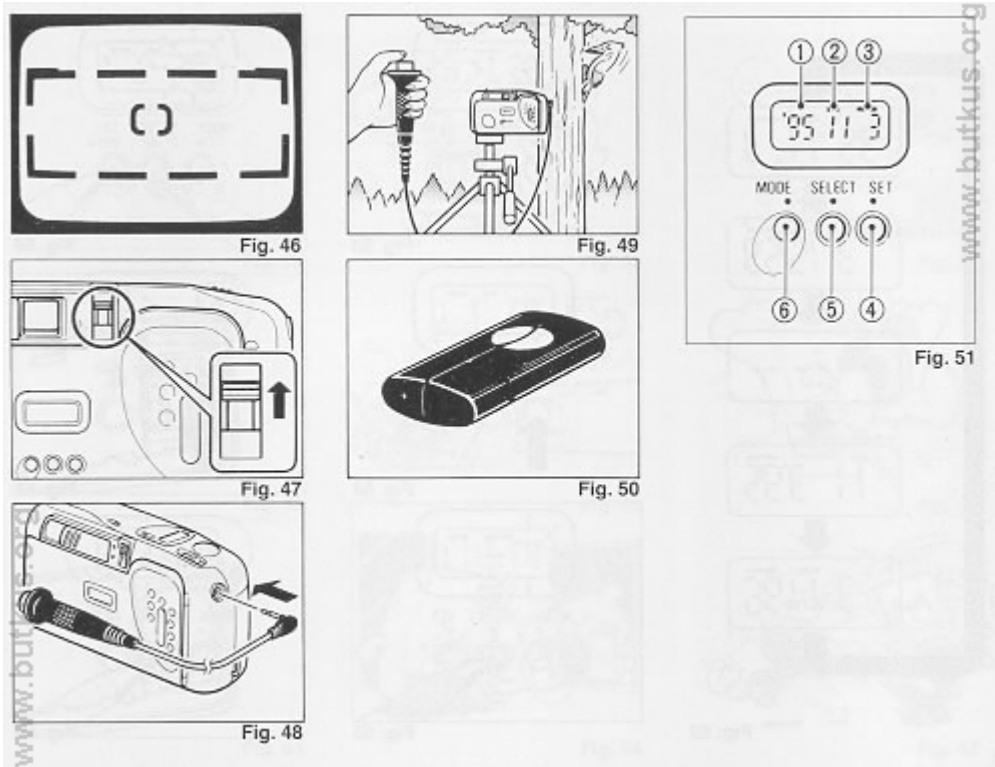

PANORAMA PICTURES

When Panorama pictures are shot, only the middle portion of the film frame is exposed, and the resulting frame is lengthened to create an impressive panorama effect. The number of frames per roll of film does not change.

1. Slide the Panorama Switch next to the viewfinder to the "P" position. **(Fig. 45)**
2. The field of view changes to the Panorama Field of View Frame. **(Fig. 46)**
3. Compose your picture within the Panorama Field of View Frame and take the picture.
4. Return the Panorama switch to the original position. **(Fig. 47)**

* Date and time cannot be imprinted during Panorama shooting.

* During close-up photography, the edges of the field of view may be omitted so allow room when you compose the picture.

To prevent blurry pictures, we recommend ISO 400 high sensitivity film.

Panorama Format Prints

You can shoot a roll of film in three possible ways, as follows:

A Standard pictures only

B Panorama pictures only

C Both Standard and Panorama pictures combined

In cases B and C, be sure to tell your photo lab which kind of pictures you want.

* When Panorama pictures are shot, only the middle portion of the frame is exposed.

* Processing for B and C may cost more and take longer than A. Therefore, please consult your photo lab.

* The conditions for development of film differ according to the area.

Therefore, please consult the store where you bought the film regarding details.

* For B and C be sure to attach the included Panorama Seal to your film.

* If you run out of the included Panorama Seals, you can order them from your camera dealer....

ELECTRONIC REMOTE CONTROL SOCKET

This camera is equipped with an Electronic Remote Control Socket. You can trip the shutter remotely in various ways by plugging an (optional) infrared sensor, remote controller, etc. into this socket. A 50 cm (19.7 in.) Electronic Cable Release cord, and a 10 m (32.8 ft) extension cord, are also available from Ricoh as options for use in remote control photography.

Typical Installation

1. Insert the plug of the Electronic Cable Release or Remote Controller to the Electronic Remote Control Socket. **(Fig. 48)** An extension cord can be used for taking photographs at a distance from subjects.

2. Using a secure support, aim the camera at the subject and gently press the remote controller button. **(Fig. 49)**

* Before inserting or pulling out a cord into/from this socket, close the Lens Shield. If the Lens Shield is left open, the shutter might accidentally be released.

Optional Wireless Remote Controller RC-10 The separately sold Wireless Remote Controller RC-10 allows you to easily use remote control photography. **(Fig. 50)**

(OPTIONAL) DATABACK SETTINGS

Nomenclature of the date imprinting feature (Fig. 51)

1. Display panel
2. Month indication
3. Imprint mark
4. Set button
5. Selector button
6. Mode selector button

Imprinting mode

Examples of date imprinting (Fig. 52)

- 1.) 1995 November 3rd
- 2.) 3rd 15:59
- 3.) No imprinting
- 4.) November 3rd, 1995
- 5.) 3rd November, 1995

The date imprinting mode can be divided into 5 types: date, time, and no imprinting.

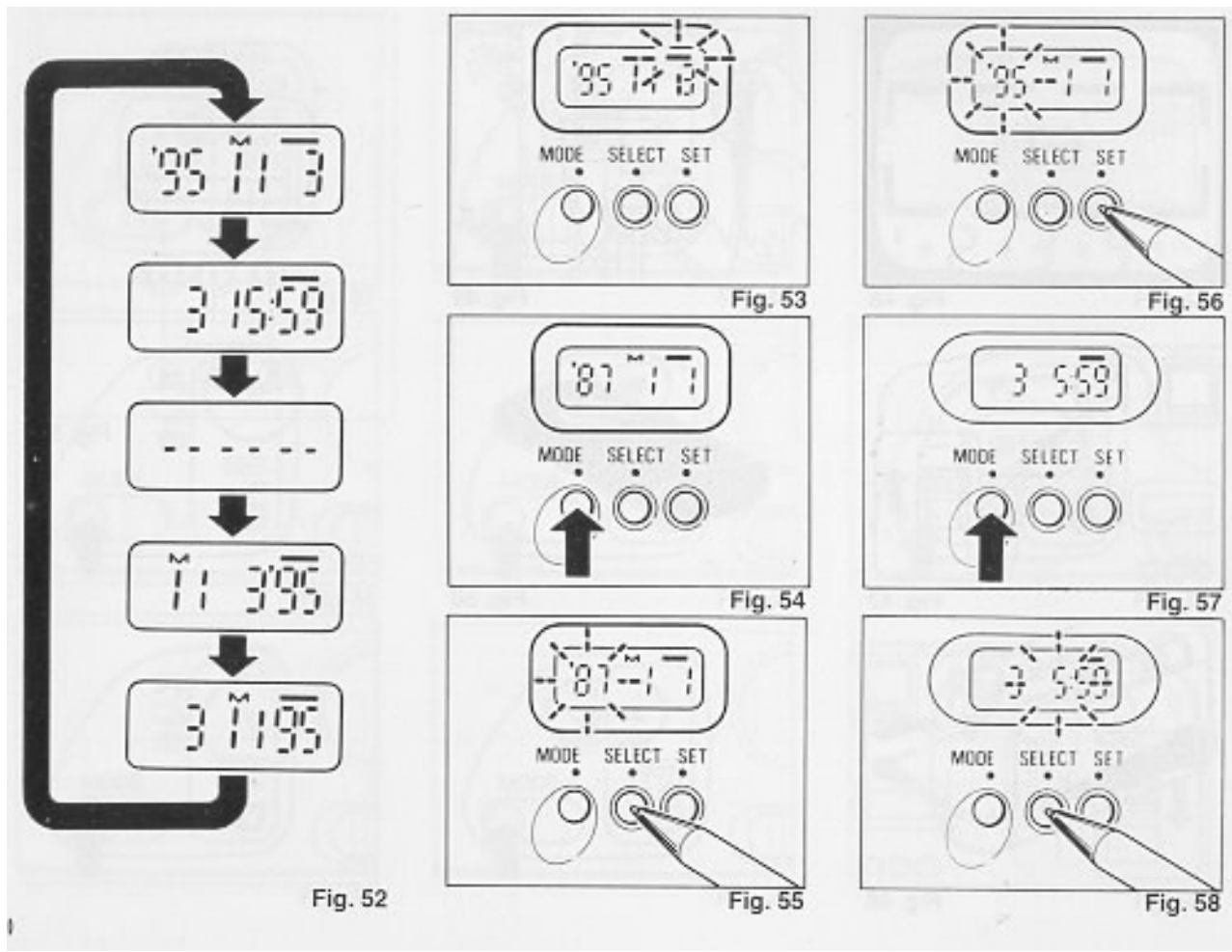

Selecting imprinting mode (Fig. 52)

Each time the Mode selector button is pressed, the display changes as shown below. Date (Year/month/day)

1. Time (Day/hour/minute)
2. No imprinting
3. Date (Month/day/year)
4. Date (Day/month/year)

Checking imprinting (Fig. 53)

After shooting, the imprint mark -- flickers in the display panel for a few seconds for correct imprinting.

The mark and the letter "M" are not imprinted on the picture.

Resetting the date and time (Fig. 54, 55, 56)

1. Each time the Selector button is pressed, the flashing digits change in the order of year, month, day, hour, minute and colon (:).
2. When the digits to be reset flash press the Set button until the desired digits appear. When the Set button is kept

pressed, the digits change rapidly.

3. Imprinting is not possible while the camera is in Reset Mode. When resetting is complete, press the Mode Selector button until the Imprint mark _ appears in the Display Panel.

Accurately setting seconds (Fig. 57, 58, 59)

1. Press the Mode selector button for Time display mode.
2. Press the Selector button so that the colon (:) flickers.
3. Press the Set button according to the radio or telephone time signal. The time count starts from 0 seconds.
4. Press the Mode Selector button.

* It is recommended that the second digits be adjusted after adjusting the minute digits.

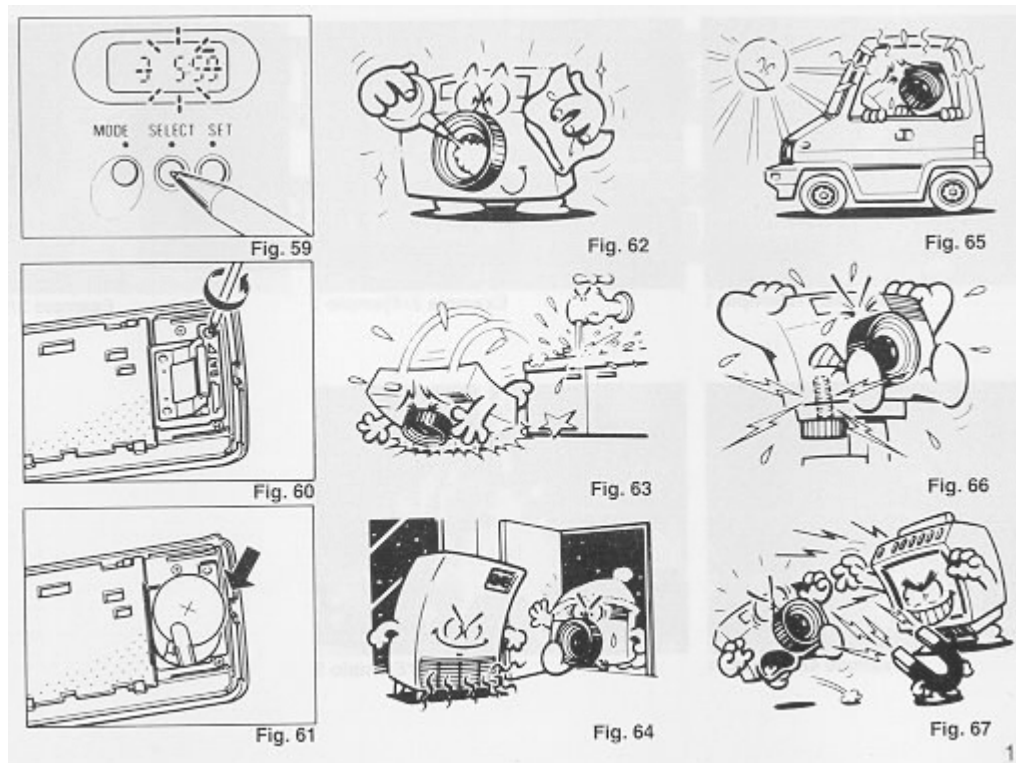

Battery Replacement (Fig. 60, 61)

1. Open the back cover.
2. Remove the screw from the databack battery compartment cover with a small (+) screwdriver.
3. Remove the battery compartment cover holding the roller section and lift up the battery.
4. Load the new battery with the side marked (+) facing upwards. Then, close the battery compartment cover using the (+) screwdriver. (Use lithium battery CR2025. The service life is about 3 years.)

* When the battery is exhausted, the imprinted digits become faint. At that time, replace the battery.

- * Do not open the date battery compartment lid except when replacing the battery.
- * Keep the battery out of reach of children. If a child swallows the battery, contact your doctor immediately.

Notes on date imprinting feature

* At temperatures below 0°C (32°F), the battery performance deteriorates. The date imprinting feature may not function correctly and imprinting may become impossible.

* When the battery is replaced, the display panel sometimes shows wrong digits. Reset the digits for correct indication.

* The date is sometimes illegible if it is imprinted on the following objects.

(1) "Warm"-colored objects, such as red, yellow, orange, etc.

(2) Objects with details similar in size to the imprinted date (gravel, leaves, etc.)

(3) Objects of high luminance (sky, white wall, etc.)

* Imprinting is not possible in the following modes.

(1) Print off mode

(2) Reset mode

(3) Battery check display mode (The display panel flashes.)

PROPER CARE OF YOUR CAMERA

* If there is dirt on the lens or Distance Measuring Windows and in the camera body, do not attempt to remove it with your fingers. Use a blower to blow the dust away, or wipe the surface gently with a soft cloth. **(Fig. 62)**

* Camera malfunction can be caused by shock, humidity, salt etc. After using the camera at the beach or places where there is salt spray, high humidity or chemicals, wipe it off carefully. **(Fig.63)**

* Take care not to expose the camera to sudden changes in temperature as they may cause condensation on the lens and inside the body, or other malfunctions. **(Fig. 64)**

* Do not expose the camera for a long period of time in extremely high temperatures, such as in your car or on the beach, as this may ruin your film, or cause other malfunctions. **(Fig. 65)**

* When using a tripod, do not try to force a long screw into the socket. The screw length should be less than 5.7 mm (1/4 in.). **(Fig. 66)**

* Do not place the camera near equipment that has strong magnetic fields such as a television or radio **(Fig 67)**

MAJOR SPECIFICATIONS:

Type: Full-automatic 35 mm autofocus lens-shutter camera with built-in ZOOM lens.

Lens: 32 mm f/4.9--64 mm f/8.8 zoom lens
6 elements 6 groups

Focus: Automatic focusing with pre-focusing facility.
0.6 m--∞ at telephoto, 0.8 m--∞ at wide angle

Self-timer: Built-in electronic type with LED indicator. Operating delay of approx. 10 sec.

Shutter: Programmed AE type electronic shutter, 1/3--1/300 sec.

Viewfinder: Albada type with bright-frame zoom viewfinder

Exposure adjustment: With CdS photocell. Programmed automatic exposure adjustment with Automatic Backlight Control system.

Exposure coupling range EV6.3 - 17 (wide), EV8.1 - 18.8 (Tele)/ISO 100

Film speed range: ISO 64--3200. Compatible with the DX code system. (Non-DX films are set to ISO 100.)

Film loading: RICOH auto-load system

Film advance/rewind: Automatic film advance and rewind, Automatic 1st frame setting, Automatic film rewind at the end of film.

Exposure counter: Additive, counts down during film rewind.

Built-in flash: Electronic flash automatically activates in dim light and backlight.

Flash range: 0.8 m (2.6 ft.) - 3.9 m (13 ft.) (at wide-angle),

0.6 m (2 ft.) - 2.1 m (7 ft.) (at telephoto) (ISO 100)

0.8 m (2.6 ft.) - 7.8 m (26 ft.) (at wide-angle),

0.6 m (2 ft.) - 4.2 m (14 ft.) (at telephoto) (ISO 400)

Interval between flashes: About 6 sec.

Other features: Red eye reduction Mode, Flash-on, Flash-off, Super Night Mode, TV Mode, Continuous Mode, Safety Lock, Electronic Remote Control Socket, Tripod Socket, Switchable panorama (Mid-roll)

Power Source: 3V lithium battery (CR-1 23A, DL-1 23A) or equivalent ____

Dimensions: 119 mm (4.7 in.) (w) x 68 mm (2.7 in.) (h) X 42.5 mm (1.7 in.) (d)

Weight: 240 g (8.10 oz.) (without battery)

* Specifications are subject to change without notice.